

### Exposed 15 mm grid system with channel feature and pre-mitred intersections - System C

#### Key features

- 6 mm reveal for a more monolithic appearance with Tegular 15 mineral tiles
- Unnotched 1200/1350 mm Cross Tees for large tile designs
- Peakform : patented design for strength, stability and easier to cut

#### Application areas

- Reception areas / Open plan office / Individual offices

#### Physical data

- Material: galvanised steel
- Surface finish: baked polyester paint
- Colour: all products available in White or White with Black Reveal

#### PERFECTLINE XL<sup>2</sup> | Main Runners White (by-pass connection)

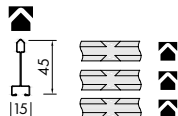
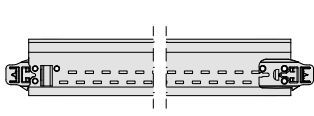

Item reference	Length	Dimensions (mm)			Content/carton		Weight/carton kg	Cartons/ pallet
		Width	Height	Slot centres	lm			
PL360GW	3600	15	45	600	20	72.00	22.40	40
PL312,5GW	3125	15	45	625	20	62.50	19.40	40
PL270GW	2700	15	45	675	20	54.00	16.80	40

#### PERFECTLINE XL<sup>2</sup> | Main Runners White with Black Reveal (by-pass connection)

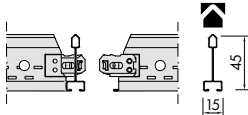

PL360GR	3600	15	45	600	20	72.00	22.40	40
---------	------	----	----	-----	----	-------	-------	----

#### PERFECTLINE XL<sup>2</sup> | Cross Tees White (stab system)

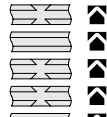
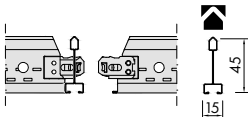

PL135GW	1350	15	45	675	20	27.00	8.30	40
PL135NGW	1350	15	45	-	20	27.00	8.30	40
PL125GW	1250	15	45	625	60	75.00	23.00	35
PL120GW	1200	15	45	600	60	72.00	22.10	35
PL120NGW	1200	15	45	-	60	72.00	22.10	35
PL67,5GW	675	15	45	-	60	40.50	12.50	70
PL62,5GW	625	15	45	-	60	37.50	11.60	70
PL60GW	600	15	45	-	60	36.00	11.10	70
PL30GW	300	15	45	-	60	36.00	11.10	70

#### PERFECTLINE XL<sup>2</sup> | Cross Tees White with Black Reveal (stab system)

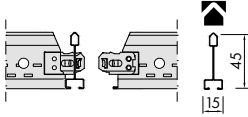

PL120GR	1200	15	45	600	60	72.00	22.10	35
PL120NGR	1200	15	45	-	60	72.00	22.10	35
PL60GR	600	15	45	-	60	36.00	11.10	70
PL30GR	300	15	45	-	120	36.00	11.10	70

#### PERFECTLINE XL<sup>2</sup> | Perimeter Trim White

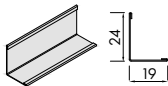

PL-T1924HD	3000	19	24	-	36	108.00	18.30	49
------------	------	----	----	---	----	--------	-------	----

### Section Drawings

#### PERFECTLINE XL<sup>2</sup> | Main Runners (bulb-to-bulb connection)

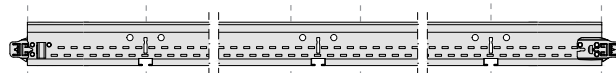

Length						
3600	300	600	3 x 600	600	300	
3125	312.5	625	2 x 625	625	312.5	
2700	337.5	675	675	675	337.5	

#### PERFECTLINE XL<sup>2</sup> | Cross Tees (stab system)

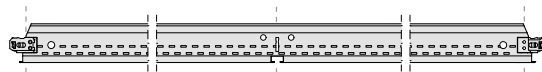

Length		
1350	675	675
1250	625	625
1200	600	600

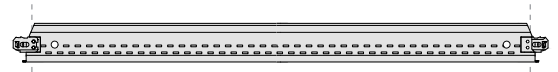

Length	
	1350 / 1200 / 675 / 625 / 600 / 300

**System Drawing - System C**

- 1** Main Runner
- 2** Long Cross Tee
- 3** Short Cross Tee
- 4** Hanger
- 5** Perimeter Trim

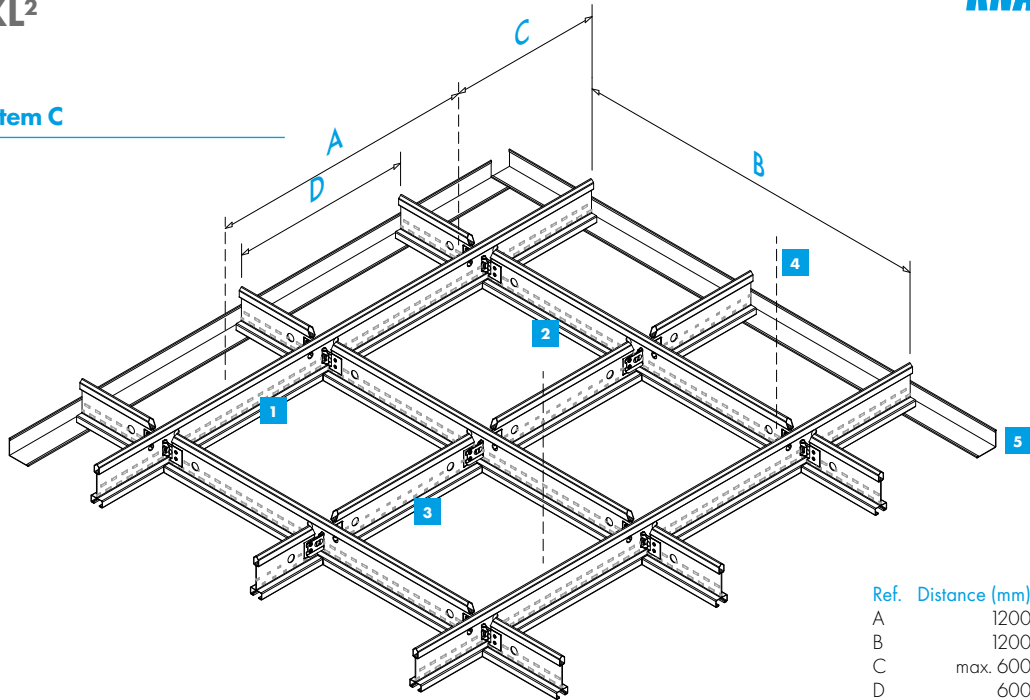

Ref.	Distance (mm)
A	1200
B	1200
C	max. 600
D	600

**Details**

- Pre-mitred intersections
- Choice of either pre-mitred and un-mitred 1200/1350 mm Cross Tees
- PERFECTLINE XL<sup>2</sup> with 6 mm reveal is supplied as standard in White and in White with Black Reveal, to compliment mineral tiles



Notched Main Runners and Cross Tees, with or without black reveal



Unnotched Cross Tees, with or without black reveal

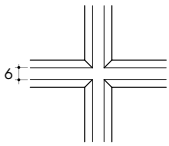

View of mitred intersection from beneath

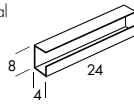

**MCC4 G**  
Mitre closure clip

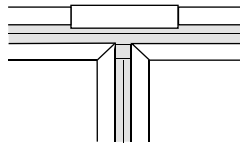

**Perimeter Solutions**

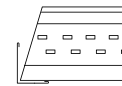

Section

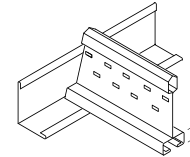

Cross Tee trimmed to perimeter trim

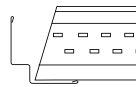

Section

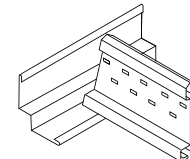

Cross Tee trimmed to Shadowline perimeter trim

**Load Table | Maximum permissible weight (kg/m<sup>2</sup>)**

Main Runner distances Hanger distance A (mm)	1200 mm	1250 mm	600 mm	625 mm
	Module 600x600, 1200x600	Module 625x625, 1250x625	Module 600x600, 1200x600	Module 625x625, 1250x625
800	13.6	11.9	25.0	25.0
1000	10.3	9.3	25.0	25.0
1200	7.1	6.6	15.7	15.1
1500	3.4	3.3	7.5	7.2

Note:  
The load per m<sup>2</sup> must be evenly distributed (no extra point loads).  
After loading, the deflection will remain within the permitted deflection according to class 1 (L/500) of EN 13964, provided the grid is laid out as shown.

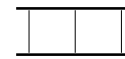
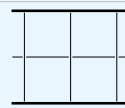

For other grid layouts, load capacities or hanger distances, please contact KnauF Ceiling Solutions.

<b>Fire reaction</b>	Euroclass <b>A1</b> as per EN 13501-1	<b>RUS KM0 (NG) / KM1 (G1, V1, D1, T1)</b> as per 123-FZ
<b>Indoor air quality</b>	A+	
<b>Cleanability</b>		
<b>Sustainability</b>	25% EN ISO 14001	
<b>Design options</b>		

All measurements in millimetres. All sizes are nominal.  
Cross Tee alignment is achieved by locating the tees to the right-hand side of the adjoining section.

Products may vary from country to country. Please contact your local sales representative.  
For further information and legal notice, please visit our website.  
[knaufceiling.com](http://knaufceiling.com)